

SIDE VIEW TOP

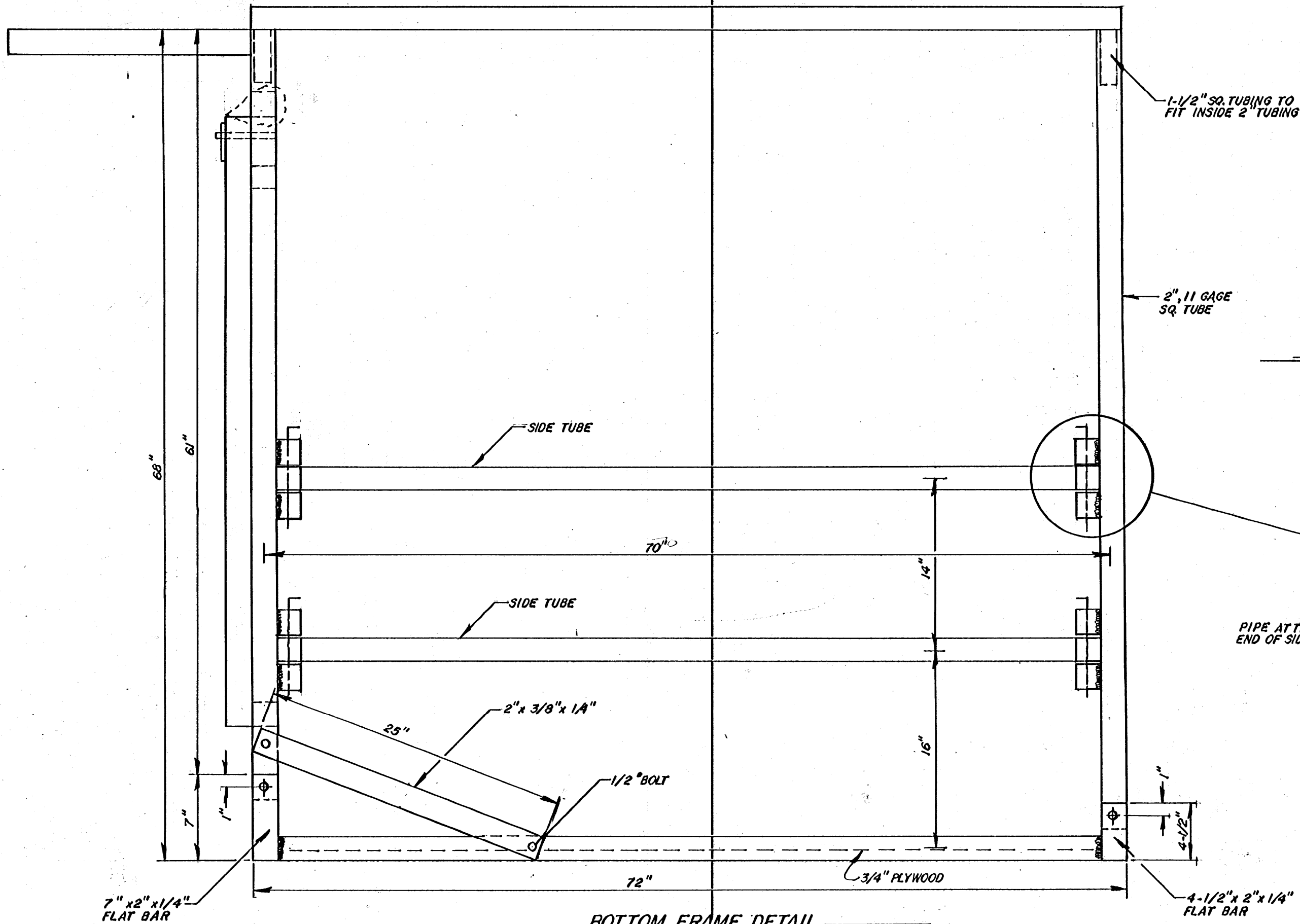

DETAIL A

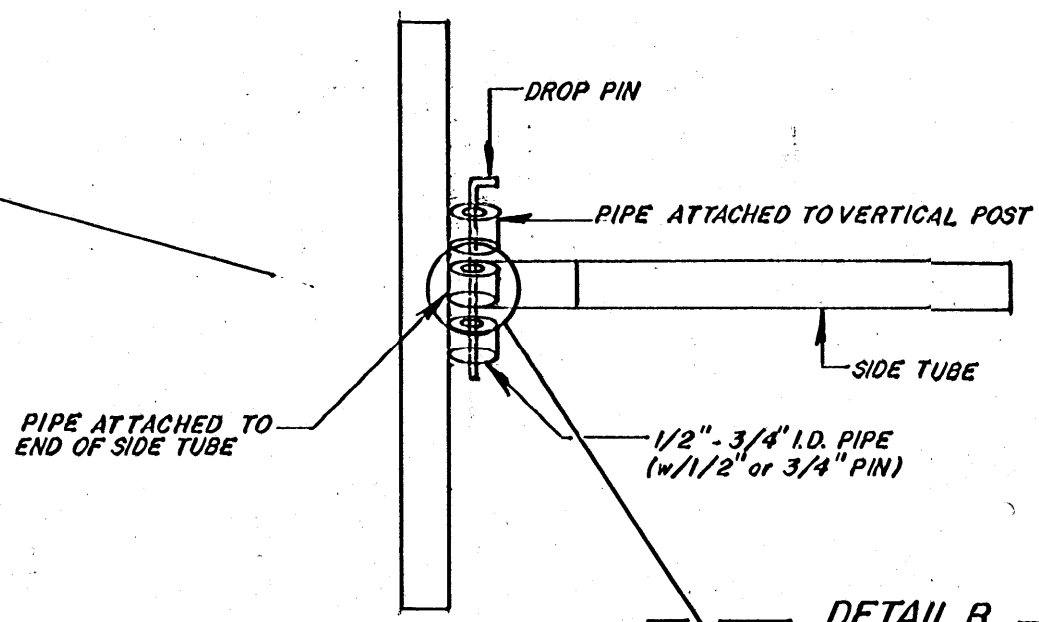

DETAIL B

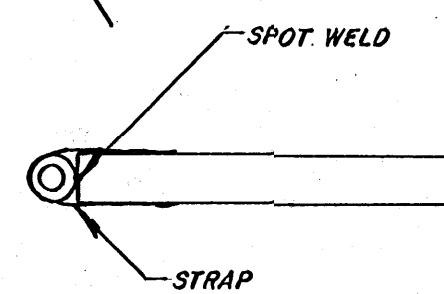

BOTTOM FRAME DETAIL

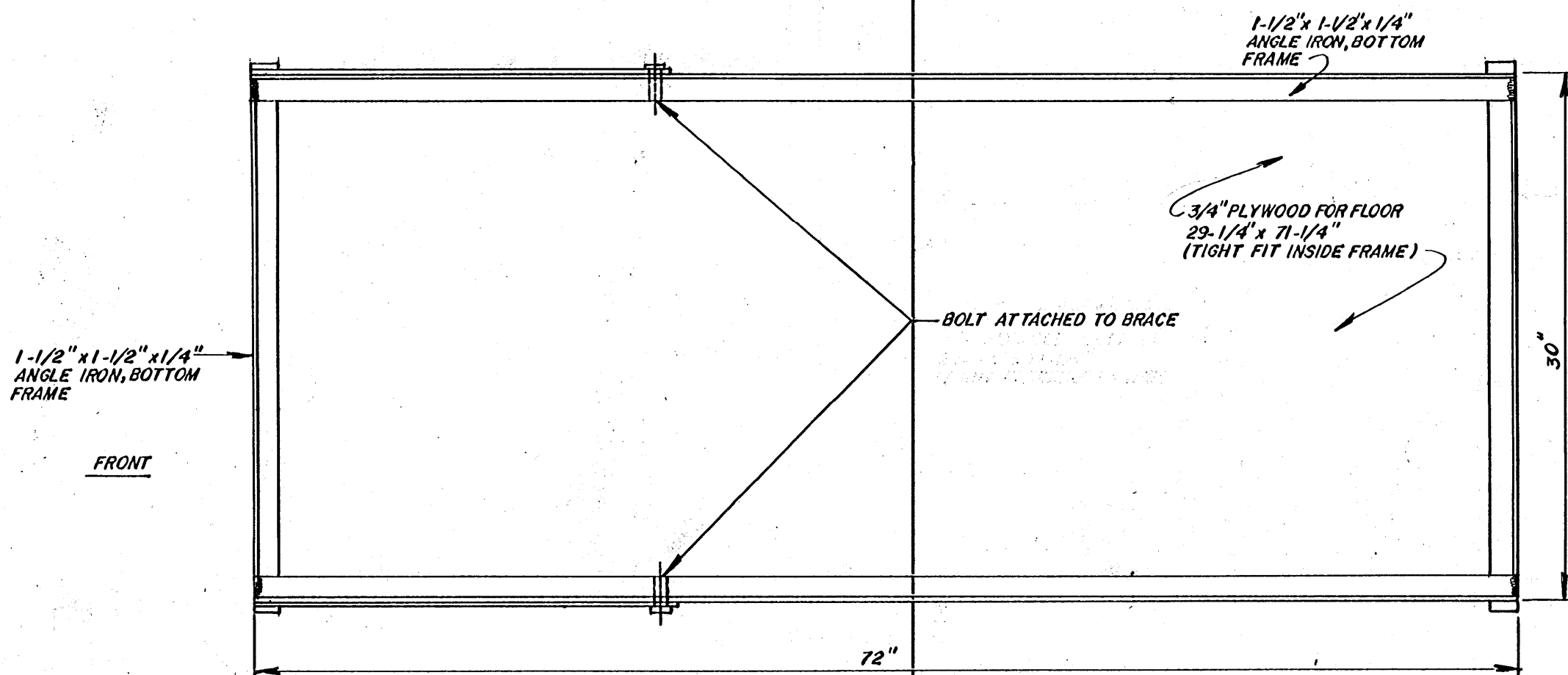

NOTES: 1. TO TRANSPORT, REMOVE SIDE BARS, FOLD BACK DOWN FIRST THEN FOLD FRONT ON TOP OF BACK

Scale: 1-1/2" = 1'-0"

SIDE VIEW TOP & BOTTOM FRAME		PL. NO. 6184 A
CATTLE TRIMMING CHUTE		
 Mississippi Cooperative Extension Service Mississippi State University USDA and Counties Cooperating	DESIGN BY DR. JAMES COLLINS	SHEET
	DRAWN BY PAM BENNETT	1
DATE JULY, 1986	OF 2	

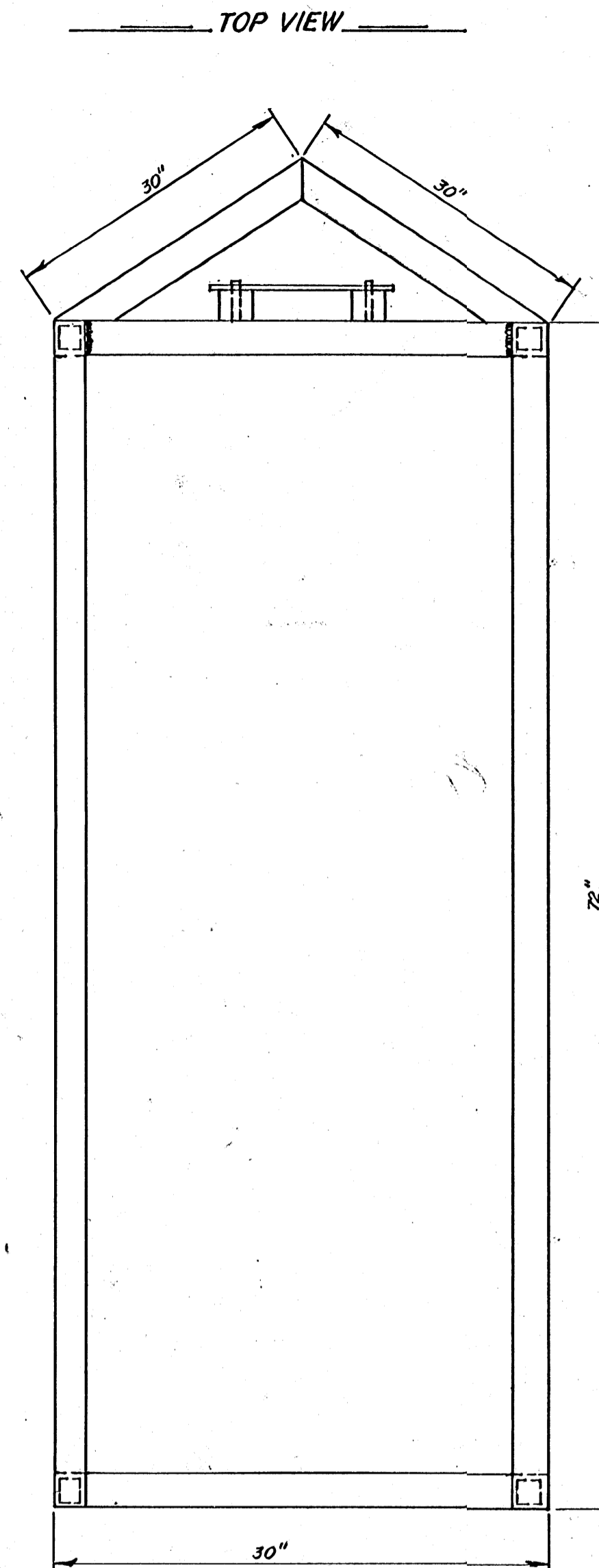
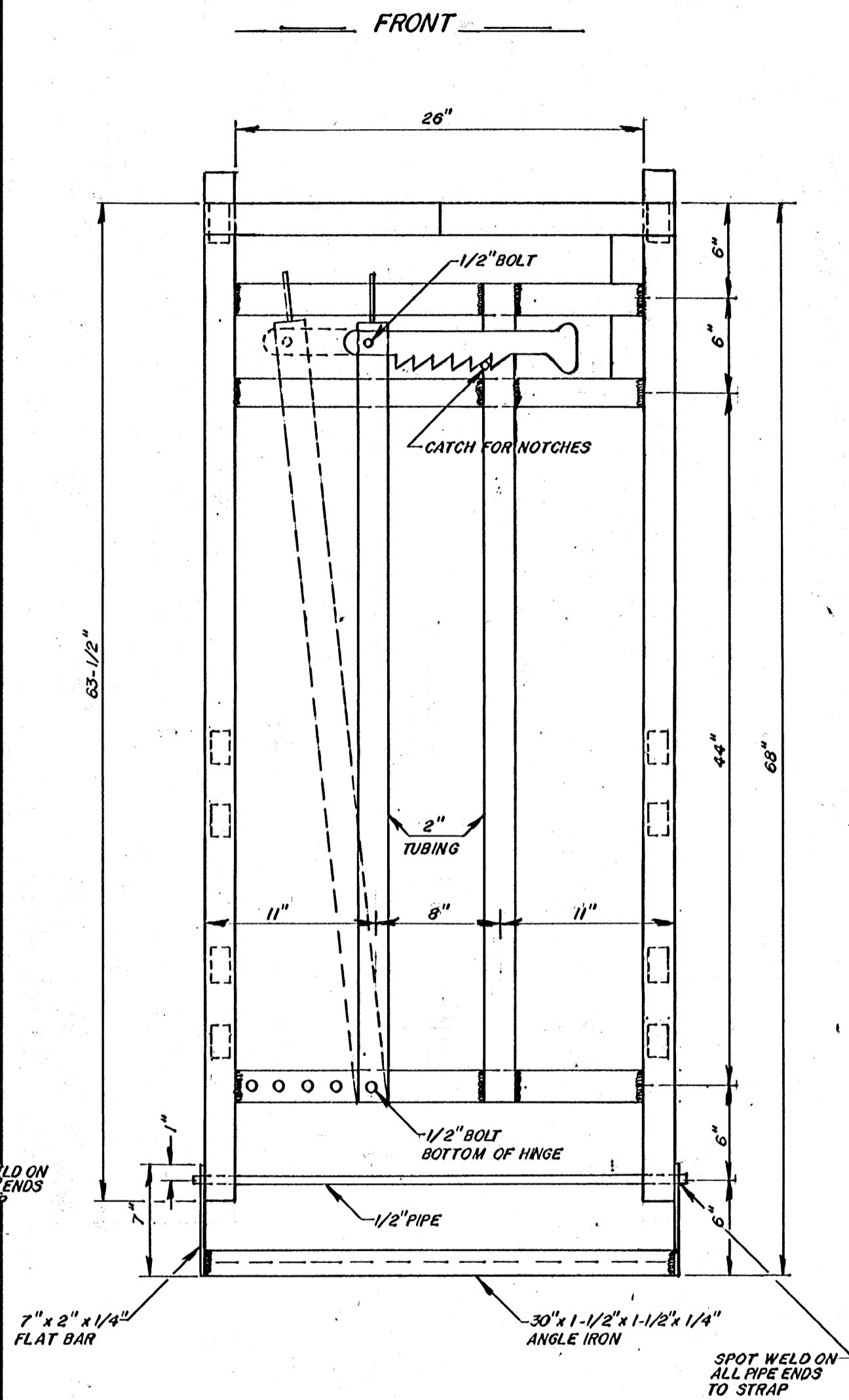
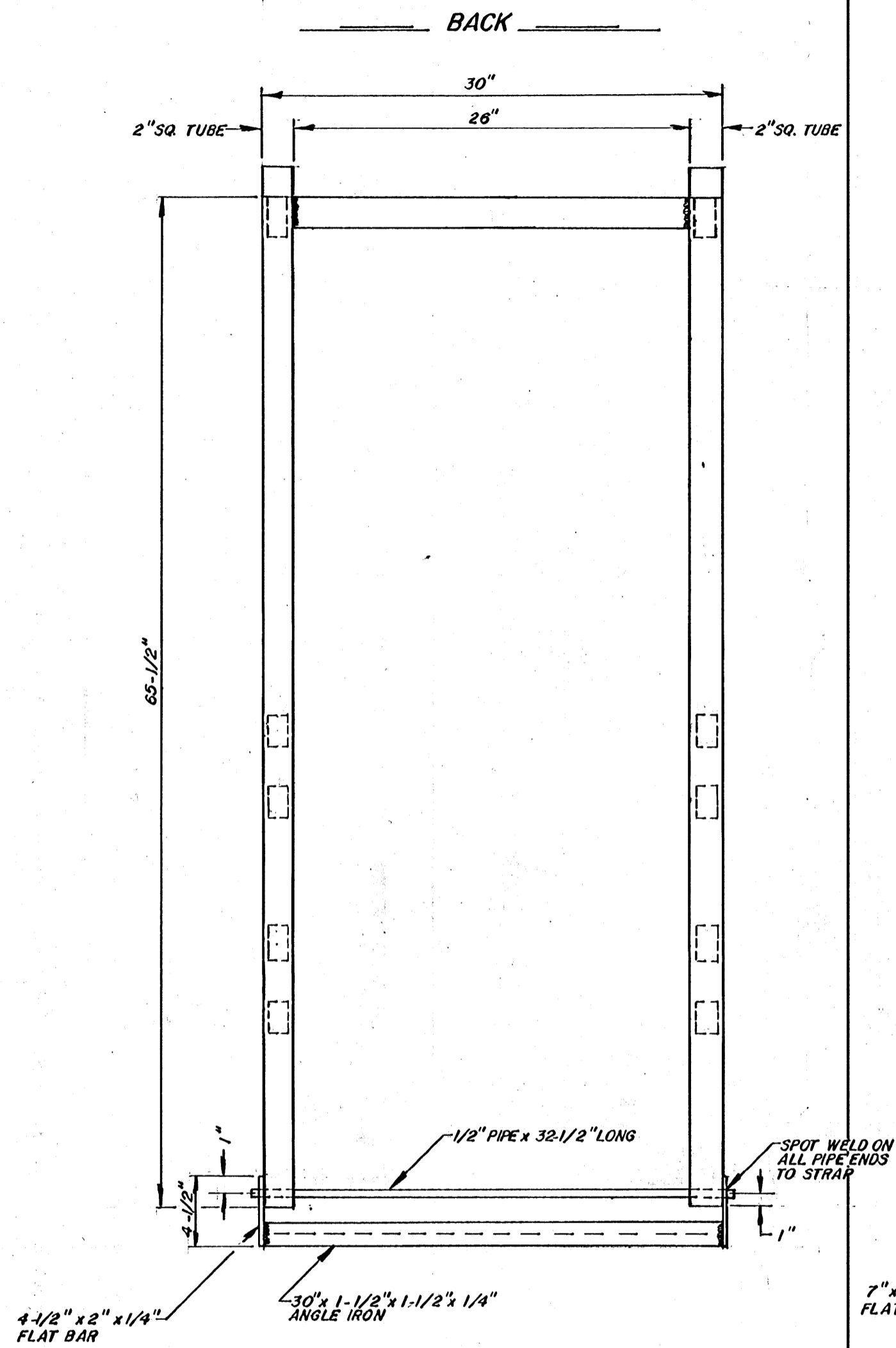

Scale: 1-1/2" = 1'-0"

BACK, FRONT & TOP VIEW

PL. NO. 6184 A

CATTLE TRIMMING CHUTE



DESIGN BY DR. JAMES COLLINS

DRAWN BY PAM BENNETT

DATE JULY, 1986

SHEET
2
OF 2